

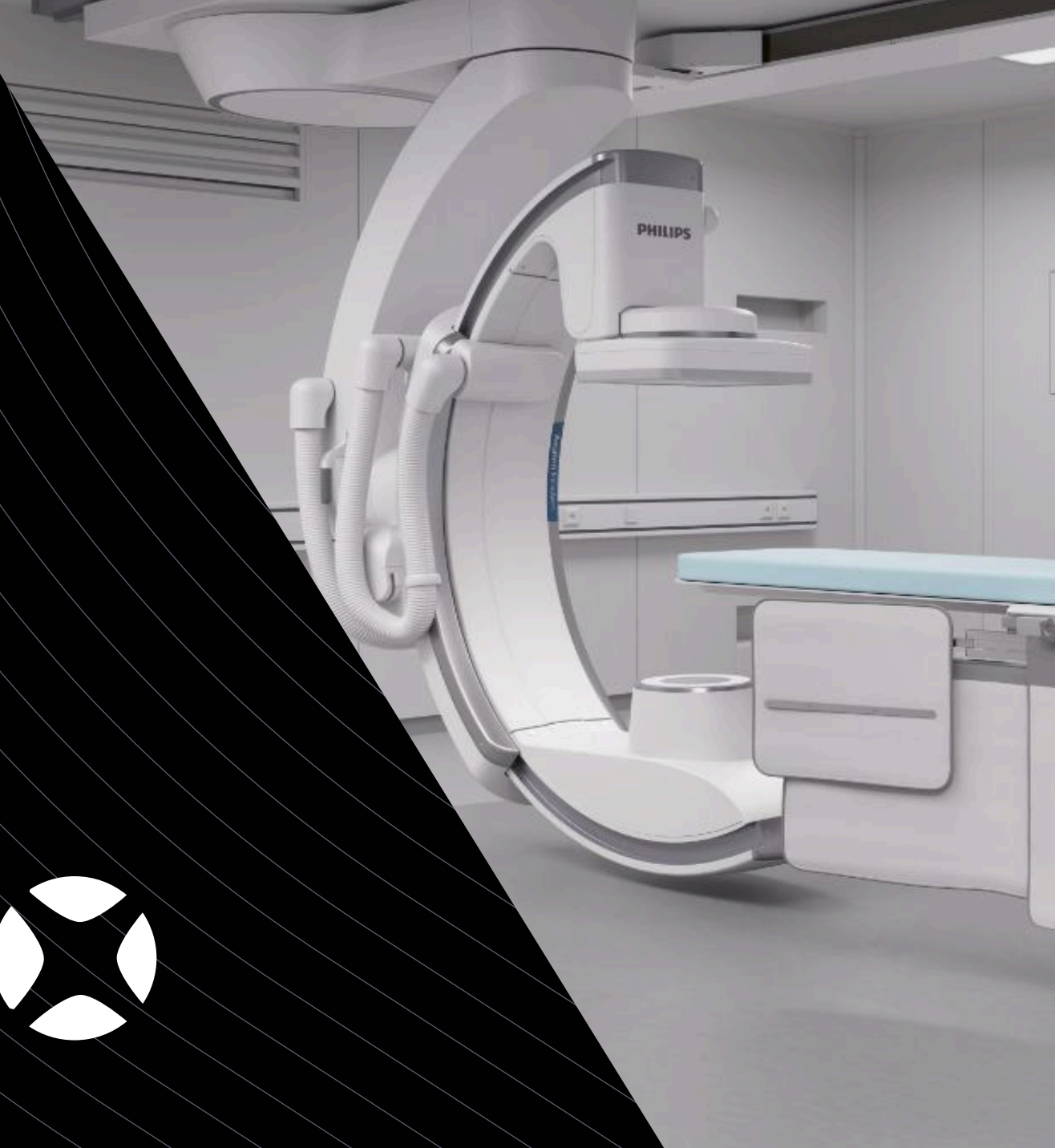

SparkBio
Innovation for Life

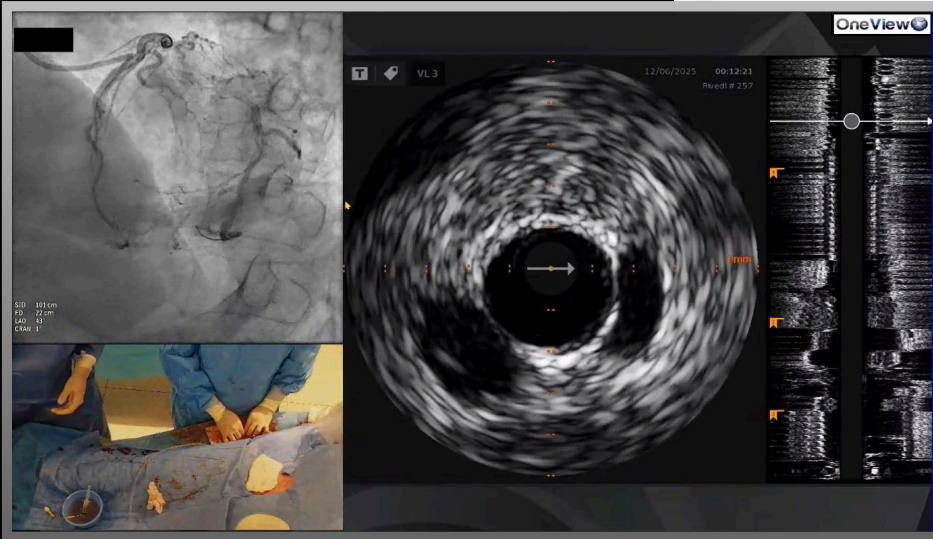

OneView 

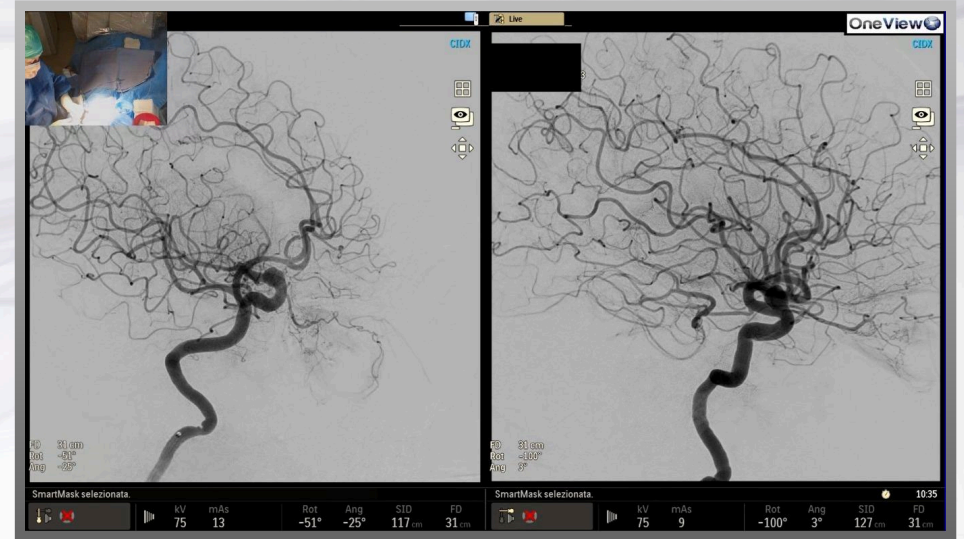
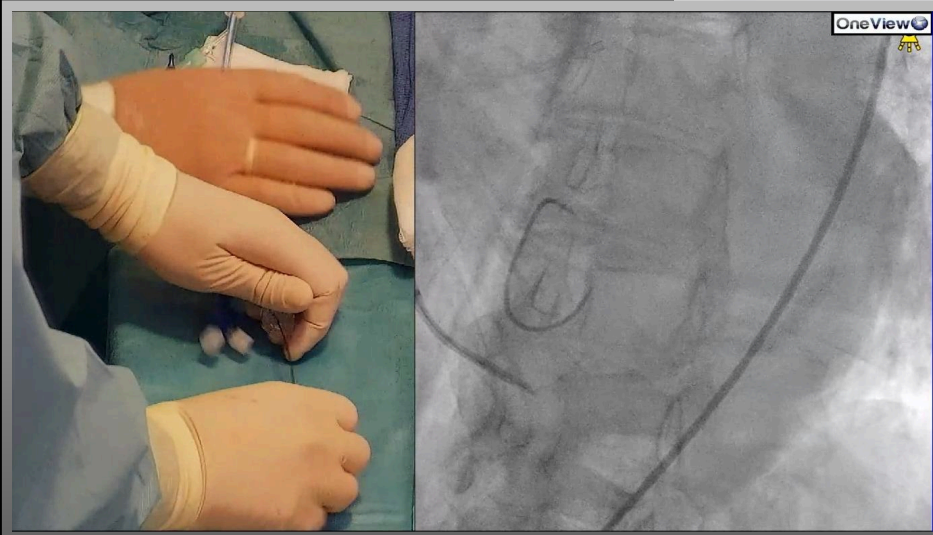



BECOME A PERMANENT LIVE CASE CENTER

Upgrade your CathLab to a **Permanent Live Case Center** to be able to open the doors of your Operating Room to the scientific community.



RECORD

Record your most important surgical procedures in Full HD video quality.

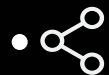

SHARE

Share your videos with the scientific community via webinars and social media.



BROADCAST

Easily invite guests by email and stream your procedures live from the angiography suite online.



AUTO-EDIT

Create highlights and short clips through Auto-Edit software that identifies key procedure phases thanks to OneViewX algorithms.



OneViewX Station

Acquire up to eight devices such as fluoroscopy, ivus, oct and polygraph monitor through a medical-grade workstation and up to two environmental cameras.

Monitor in the OR

Display the OneViewX signal in the OR through a dedicated monitor or connection to the existing large screen.

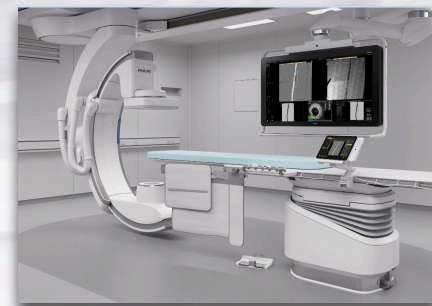

Wireless Audio Headsets

Interact with your audience using top performance wireless audio headsets.

Environmental Camera

Record the intervention integrating up to two 4K environmental cameras (zoom, pan and tilt).



Remote Controller

Pilot the system from the OR through the remote controller (like a television).

HARDWARE

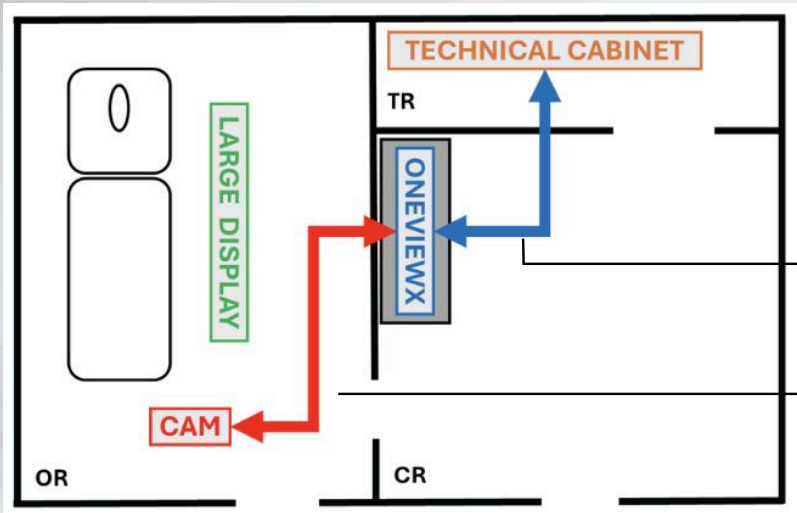

IN YOUR OPERATING ROOM

- 1 corrugated pipe for a 9-core Optical Fiber cable to Technical Cabinet.
- 1 corrugated pipe for custom Video Camera cable (CAM).



FULL CONTROL AT A SINGLE POINT

Through the **FlexSpot technology** available on Philips Azurion it is possible to achieve the **maximum level of integration** with OneViewX, making the **user experience intuitive and immediate**.

ONE CLICK

EVERYTHING YOU NEED IS JUST A CLICK AWAY!

HIGHLIGHTS

Mark an interesting step of the procedure and the software will automatically create short clips.

START MEETING

Send an invite by email to a remote participant and start the live transmission.

CHANGE LAYOUT

During the recording and Live case you can change the video layout to be displayed.

CHANGE VIEW

Change the graphical view and represent the right video sources.



The **remote controller** allows the physicians to pilot the system from the OR, **without needing a dedicated technician.**

ADVANCED TOOLS

SMART RECORDING

CUSTOM LAYOUTS

Create unlimited graphic layouts and select it from the Operating Room using the remote controller.

CROPPING VIDEO

Focus on the most interesting parts of each source and optimize their display on the screen.

PICTURE IN PICTURE

Create dynamic graphic layouts with customizable overlapping video sources.

POWERPOINT SLIDES

During the recording and Live case you can add PowerPoint slides to introduce the procedure.

AUTOMATIC VIDEO EDITING

AUTO-MARKING

The software identifies key procedure phases by detecting device usage and listening to operator's voice comments.

The video editing tool can accelerate the speed of video clips to further reduce the duration of the final edited video.

DATA ANONYMIZATION

Recorded videos are natively anonymized, ensuring that no videos can be linked to a specific patient or procedure. Sensitive informations are fully absent from both the stored video file and during the broadcast itself.

01

WARNING

At system startup a warning message is displayed for the operator as a reminder of good privacy practices.

02

ENCRYPTION

During the live streaming any external user's access to the system is protected by advanced encryption features.

03





04

DATA OWNERSHIP

All the recorded videos are stored locally and are of exclusive property of the hospital center and its physicians.

05

SHARING

Only the physician can share the stored video transferring it to external devices.

06

PRIVACY GUIDELINES

With each new installation, physicians receive training on the privacy guidelines they must adhere to while using the system.

SCHEDULE YOUR DIGITAL EVENTS IN ADVANCE

Use OneViewX to **build a digital event** and share the connection link **in advance**.
The software will **invite** all the guests **by email** and will **inform** them as soon as the live **streaming is starting**.

REMOTE TECHNICAL SUPPORT

Use your smartphone to read a **QR code** and open your dedicated **chat** to ask for **support by remote** in real time.

INTENDED FOR USE

In accordance to section 201(h) of the Federal Food Drug & Cosmetic (FD&C) Act and to European Union Medical Device Regulation (new MDR,ex. Medical Devices Directive 93/42/EEC – 2007/47/CE) OneViewX **is not a medical device** as it is not intended for diagnosing diseases or other conditions, nor for curing, mitigating, treating, or preventing diseases in humans or animals. OneViewX is not intended to be used as an accessory for any specific medical device.

ABOUT US



SparkBio is an innovative **MedTech company** founded in 1995 on a passion for medical technologies and backed by proven expertise in product development, that provides **cutting-edge tools for healthcare professionals.**

SparkBio partners with all the leading companies in the angiography industry **to support the global distribution** of their products. Customers **can request OneViewX** from their angiography system supplier or a local distributor based on their specific geography.



OneViewX is designed to **revolutionize digital education** in interventional cardiology, electrophysiology, interventional radiology and vascular surgery. It provides the standard solution for medical recording, video editing and livestreaming from angiographic rooms, while creating a **global network of permanent live case centers for sharing techniques among top experts.**

OneView 

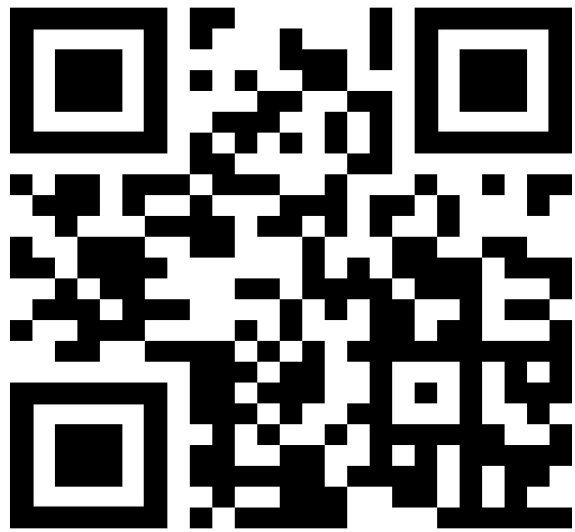

FOLLOW US

 info@SparkBio.it

 **Via Caselle 76
San Lazzaro di Savena (BO)
40068 – Italy**

 **+39 051 463269**

©SparkBio. All rights reserved. Reproduction of this document is strictly prohibited without express written consent of SparkBio Srl. ONEVIEWX is a registered trademark of SparkBio Srl. In accordance with data privacy and protection laws in the European Union and other countries, all patient data that appear in this document are fictitious. No actual patient information is shown. Some of the images featured in this brochure have been kindly provided by Philips.

